

Article number: 51030568000010

Description: Vibration damper GS-M2
200x60x2000-15, NR shore 57

Measures

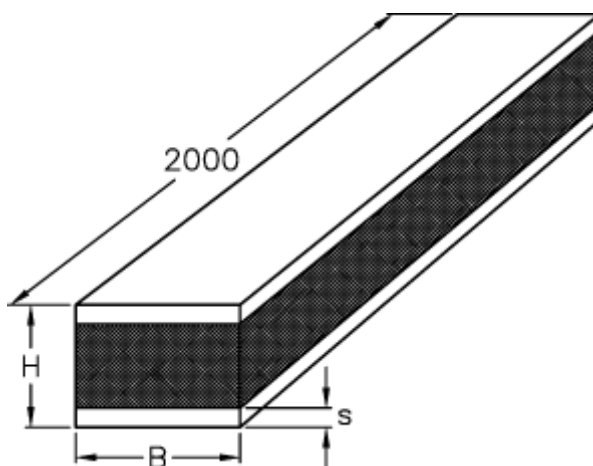

B = 200

H = 60

S = 15